













## LKW-Bühne P 300 KS Facelift

### TECHNISCHE DATEN

	Gesamtgewicht*	7490 kg		max. seitr. Reichweite*	20,50 m
	Transportlänge	7,60 m		Schwenkbereich Drehtisch	540°
	Transportbreite	2,52 m		Drehwinkel Arbeitskorb	+/-85°
	Transporthöhe	3,50 m		Drehwinkel Korbarm	195°
	Abstützbreite	5,00 m		Größe Arbeitskorb	1,80 x 1,0 x 1,10 m
	max. Arbeitshöhe	30 m		max. Korblast	400 kg
	max. Korbbodenhöhe	28 m			

\* In Abhängigkeit vom Lkw-Fahrgestell

### ARBEITSDIAGRAMME

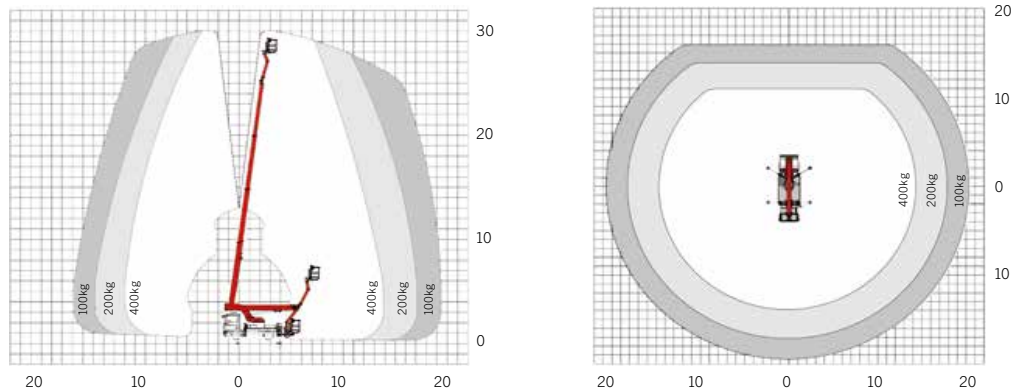

2% Toleranz bauteilbedingt möglich

### ABMESSUNGEN

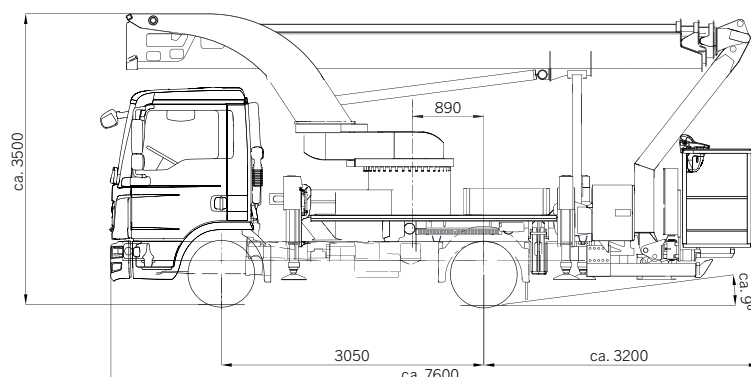

3

